

# Friggebod 9,9m<sup>2</sup> Original

med ett fönster och veranda 4m<sup>2</sup>.



**SORSELESTUGAN**

Ver. 1.3

**Art.Nr: 45SS9-0-1F + 45V-4**

Tel. +46 952 12222 Mail: info@sorselestugan.se www.sorselestugan.se

Skala 1:100 om ej annan anges. Utstick knutar: 150mm

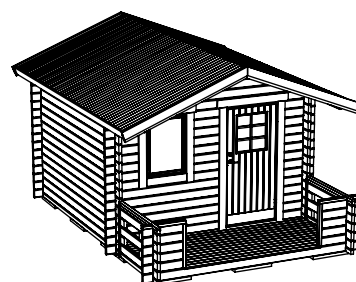
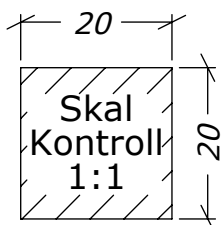
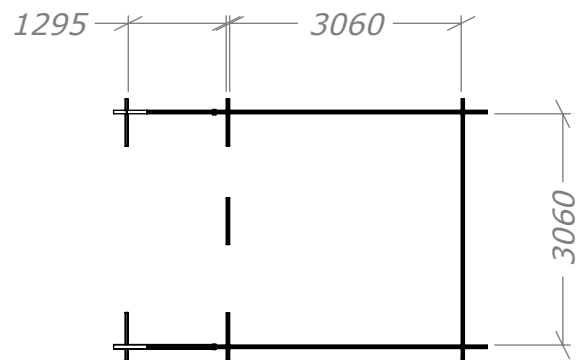
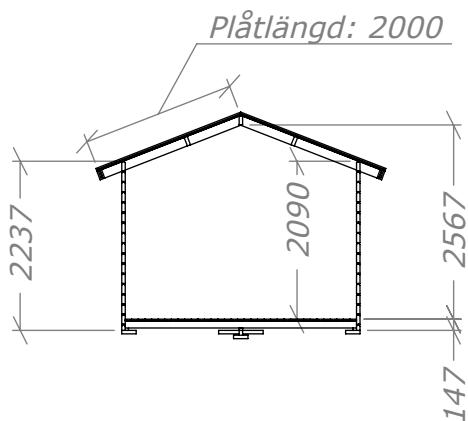
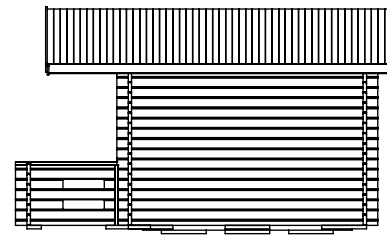
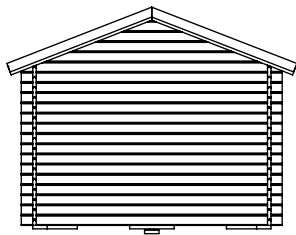
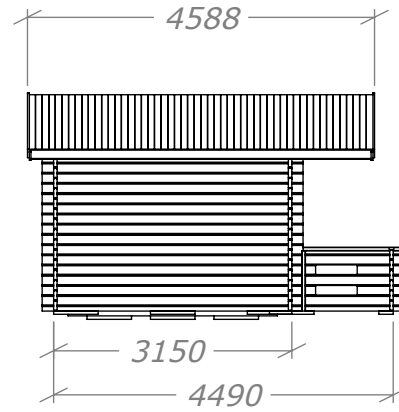
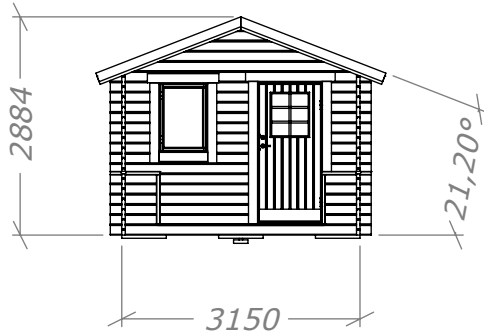

# Friggebod 9,9m<sup>2</sup> Original

Plintritning





**SORSELESTUGAN**

**Art.Nr: 45SS9-0-1F + 45V-4**

Tel. +46 952 12222 Mail: [info@sorselestugan.se](mailto:info@sorselestugan.se) [www.sorselestugan.se](http://www.sorselestugan.se)

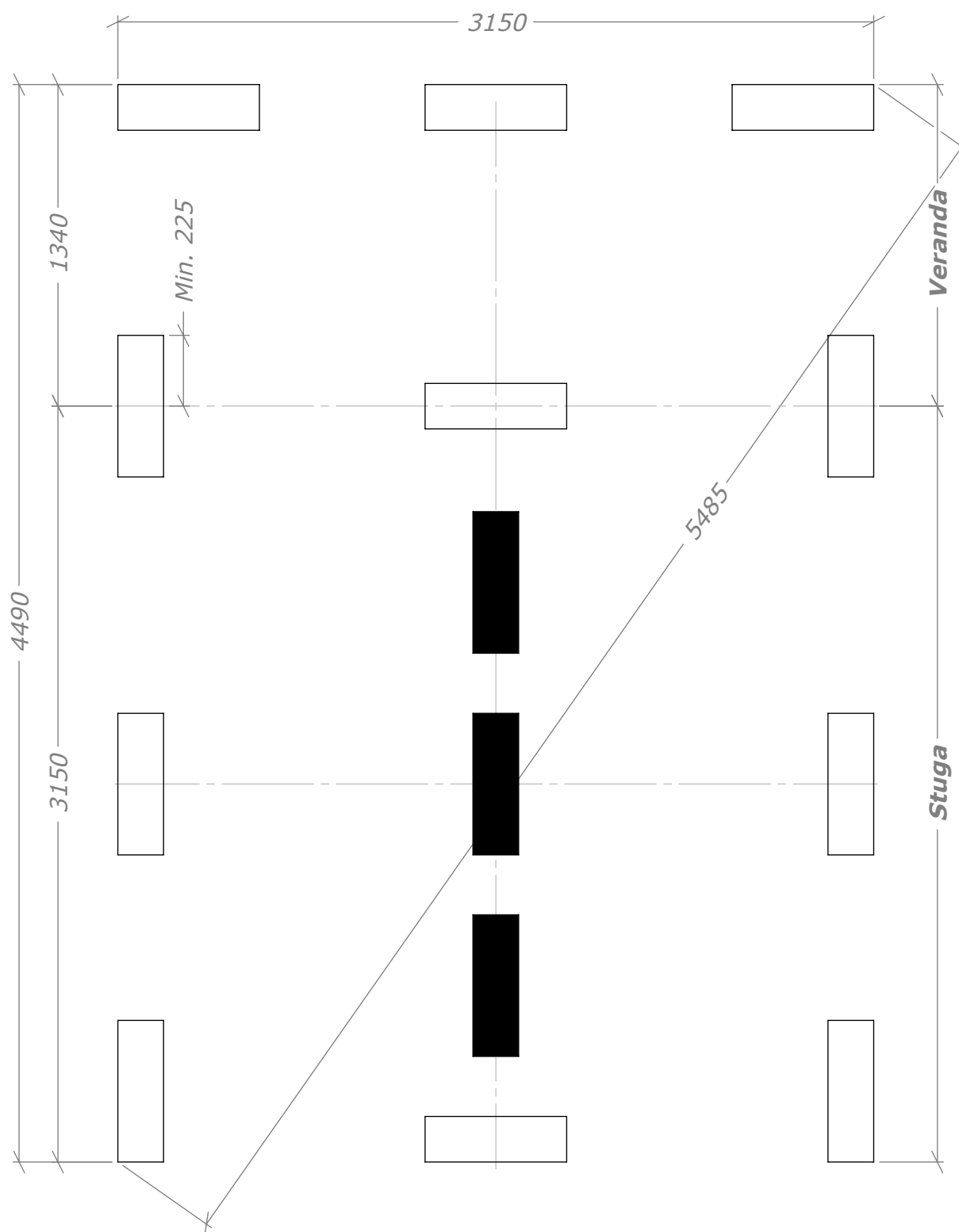
Ver. 1.3



 =65mm lägre.

# Friggebod 9,9m<sup>2</sup> Original

Plintritning - Runda



**SORSELESTUGAN**

Ver. 1.3

**Art.Nr: 45SS9-0-1F + 45V-4**

Tel. +46 952 12222 Mail: info@sorselestugan.se www.sorselestugan.se

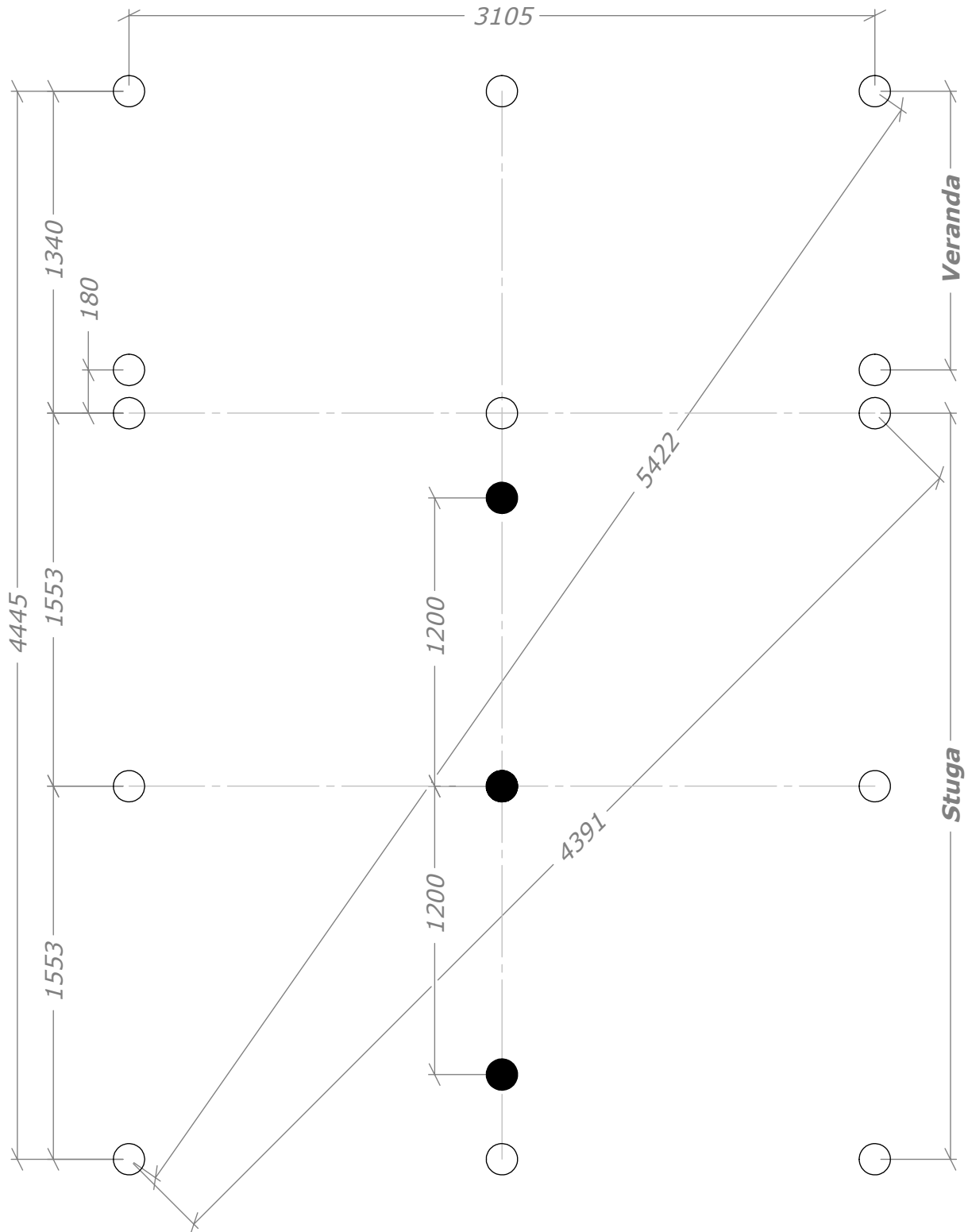

● =65mm lägre.