

# Bastu 8m<sup>2</sup>



**SORSELESTUGAN**

Ver. 1.6

**Art.Nr: 45BS8-0**

Tel. +46 952 12222 Mail: info@sorselestugan.se www.sorselestugan.se

Skala 1:100 om ej annan anges. Utstick knutar: 150mm

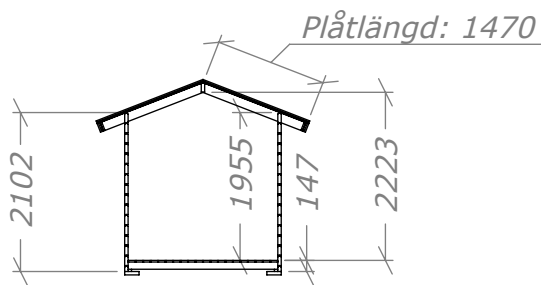
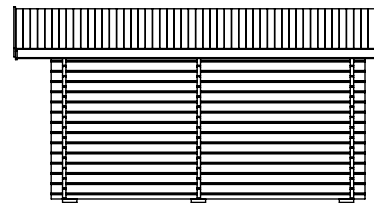
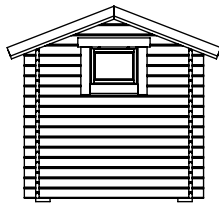
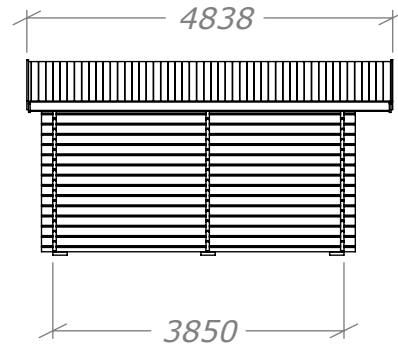
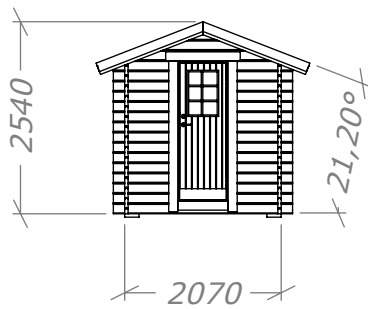

*Omklädning*

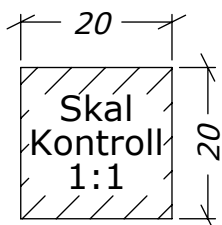
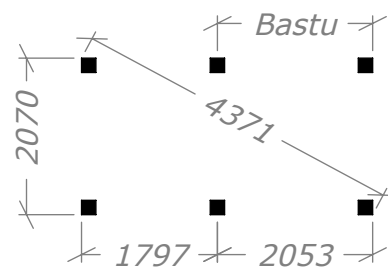
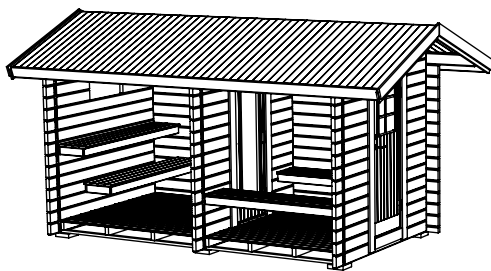
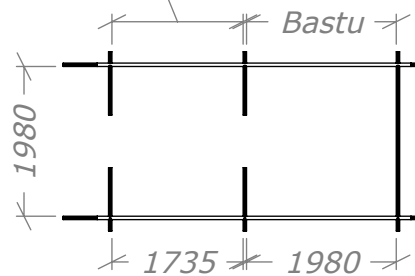

Bastun levereras med 2st bänkar för omklädningen och 2st lavar för bastudelen. En ytterdörr samt en bastudörr ingår. Fönstret placeras av kund på valfri plats.